



CONDENSING TANKLESS GAS WATER HEATER

Owner's Guide

Models : NCC300DV (GQ-C5032WZ-FF US)
NCC300OD (GQ-C5032WZ US)

FOR USE IN COMMERCIAL OR MANUFACTURED HOME APPLICATIONS.



WARNING

If the information in this manual is not followed exactly, a fire or explosion may result causing property damage, personal injury, or death.

- Do not store or use gasoline or other flammable vapors and liquids in the vicinity of this or any other appliance.
- WHAT TO DO IF YOU SMELL GAS
 - Do not try to light any appliance.
 - Do not touch any electrical switch; do not use any phone in your building.
 - Immediately call your gas supplier from a neighbor's phone. Follow the gas supplier's instructions.
 - If you cannot reach your gas supplier, call the fire department.
- Installation and service must be performed by a qualified installer, service agency or the gas supplier.



Low NOx Approved
by SCAQMD
14 ng/J or 20 ppm
(Natural Gas Only)



Thank you for purchasing this Noritz Tankless Gas Water Heater. Before using, please:

Read this manual completely for operation instructions.

Completely fill out the warranty registration card (included separately) and mail the detachable portion to Noritz America Corporation.

Keep this manual (and the remainder of the warranty registration card) where it can be found whenever necessary.

Installation must conform with local codes, or in the absence of local codes, the National Fuel Gas Code, ANSI Z223.1/NFPA 54 - latest edition and/or the Natural Gas and Propane Installation Code CSA B149.1 - latest edition.

When applicable, installation must conform with the Manufactured Home Construction and Safety Standard, Title 24 CFR, Part 3280 or the Canadian Standard CAN/CSA-Z240 MH Mobile Homes, Series M86. Noritz America reserves the right to discontinue, or change at any time, the designs and/or specifications of its products without notice.

NORITZ America Corporation

SBB80YY
Rev. 08/17



SBB80YY

Important Safety Information-1



To prevent damage to property and injury to the user, the icons shown below will be used to warn of varying levels of danger.

Every indication is critical to the safe operation of the water heater and must be understood and observed. Potential dangers from accidents during installation and use are divided into the following four categories. Closely observe these warnings; they are critical to your safety.

■ Icons warning of risk level



This is the safety alert symbol. It is used to alert you to potential personal injury hazards. Obey all safety messages that follow this symbol to avoid possible injury or death.

	DANGER	DANGER indicates an imminently hazardous situation which, if not avoided, will result in death or serious injury.
	WARNING	WARNING indicates a potentially hazardous situation which, if not avoided, could result in death or serious injury.
	CAUTION	CAUTION indicates a potentially hazardous situation which, if not avoided, may result in minor or moderate injury.
CAUTION		CAUTION used without the safety alert symbol indicates a potentially hazardous situation which, if not avoided, may result in property damage.

■ Other icons

 Electric Shock.	 High Temperature.	 Be sure to do.	 Ground.	
 Prohibited	 No flame.	 Don't touch.	 Don't disassemble the equipment.	 Don't touch with a wet hand.

DANGER



Prohibited

Vapors from flammable liquids will explode and catch fire causing death or severe burns.

Do not use or store flammable products such as gasoline, solvents or adhesives in the same room or area near the water heater.

Keep flammable products:

1. Far away from the water heater.
2. In approved containers.
3. Tightly closed.
4. Out of children's reach.

Vapors:

1. Cannot be seen.
2. Vapors are heavier than air.
3. Go a long way on the floor.
4. Can be carried from other rooms to the main burner by air currents.



Prohibited

Hot Water Heater temperatures over 125°F (52°C) can cause severe burns instantly or death from scalding.

Children, disabled and elderly are at the highest risk of being scalded. Feel water temperature before bathing or showering. Temperature limiting valves are available, ask professional person.

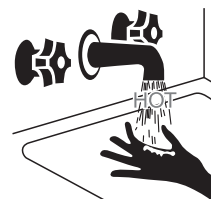

(Continued)



Prohibited

[NCC300DV]

Do not use the water heater if the intake/exhaust pipe is displaced, has holes, is clogged or is corroded.

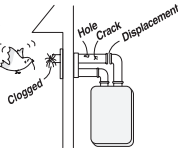

Prohibited

[NCC300D]

Do Not Install Indoors.

This will cause carbon monoxide poisoning and a potential fire hazard.

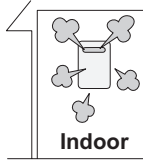

Prohibited

Do not allow anyone to change the water temperature while hot water is being used.

To prevent scalding, do not change the water temperature to a higher setting.



Be sure to do.

[When supplying combustion air from the indoors]

Check whether or not the air supply vent is blocked with dust, trash, a towel, or the like.

Blocking the opening may result in incomplete combustion.

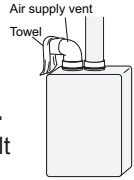

Be sure to do.

After the water heater has been out of use for a long time make sure that you fill the condensate trap with water.

This is to prevent dangerous exhaust gases from entering the building.

Failure to fill the condensate trap could result in severe personal injury or death. (Refer to page 34 for further instructions.)

! WARNING



No flame.

A. This water heater does not have a pilot. It is equipped with an ignition device that automatically lights the burner. Do not try to light the burner by hand.

B. BEFORE OPERATING smell all around the water heater area for evidence of leaking gas. Be sure to smell next to the floor because some gas is heavier than air and will settle on the floor.

WHAT TO DO IF YOU SMELL GAS.

- Do not try to light any appliance.
- Do not touch any electrical switch; do not use any phone in your building.
- Immediately call your gas supplier from a neighbor's phone. Follow the gas supplier's instructions.
- If you cannot reach your gas supplier, call the fire department.

C. Use only your hand to turn the gas valve knob. Never use tools. If the knob will not turn by hand, don't try to repair it. Call a qualified service technician. Force or attempted repair may result in a fire or explosion.

D. Do not use this water heater if any part has been under water. Immediately call a qualified service technician to inspect the water heater and to replace any damaged parts.



Be sure to do.

When a gas leak is noticed:

1. Stop use immediately.
2. Close the gas valve. **[NCC300DV]**
3. Open windows and doors.



Be sure to do.

If you detect abnormal combustion or abnormal odors, or during an earthquake, tornado or fire:

1. Turn off the hot water supply.
2. Turn off the power to the water heater.
3. Turn off gas and water supply valve.
4. Call the nearest Noritz agent.



Prohibited

Explosion Hazard ;

If the temperature and pressure relief valve is dripping or leaking, have a qualified service technician replace it. Do not plug or remove the valve.

Failure to follow these instructions can result in fire or explosion, and personal injury or death.



High Temperature.

Check the temperature of the running hot water before entering the shower.



Check the temperature before stepping into the bath tub.



(Continued)

Important Safety Information-2

(Continued)

WARNING



Do not place the exhaust vent terminal in an indoor environment by means of adding walls and ceiling (Do not enclose using corrugated sheets, etc.)

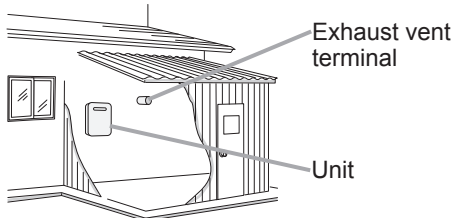

Carbon monoxide poisoning or fire may occur as a result.



[NCC300DV] Do not place outdoors.

Rain may enter the unit or the burner fire may be blown by the wind, causing malfunction or fire as a result.



Leave the proper clearance between the water heater and nearby objects (trees, timber, boxes with flammable materials etc.).

[NCC300DV]

Upper: Min. 12" (300mm) Sug. 3" (75mm) from vent pipe*

Left side: Min. 3" (75mm) Right side: Min. 3" (75mm)

Front: Sug. 24" (600mm)*

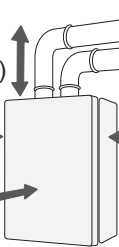

[NCC300OD]

Upper: Min. 36" (900mm)

Left side: Min. 6" (150mm) Right side: Min. 6" (150mm)

Front: Sug. 24" (600mm)*

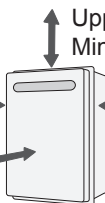

* Indicates suggested clearances for maintenance.



Do not place combustibles such as laundry, newspapers, oils etc. near the heater or the exhaust vent terminal.

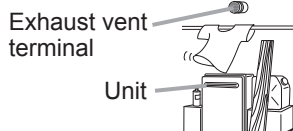

Carbon Monoxide Poisoning Hazard. Do not install this water heater in a recreational vehicle or on a boat. Do not install this water heater in a mobile home when using SV conversion kit ("SV" configuration).



Do not use combustible chemicals such as oil, gasoline, benzene etc. in the near the heater or the exhaust vent terminal.



Do not store or use gasoline or other flammable vapors and liquids in the vicinity of this or any other appliance.



Do not place or use a spray can near the water heater or the exhaust vent terminal.



Be sure the gas/power supplied matches the gas on the rating plate.

Ex. For Natural Gas (NCC300DV (GQ-C5032WZ-FF US))

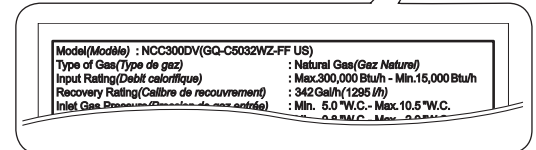
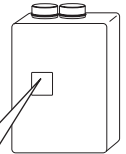

Installation and service must be performed by a qualified installer, service agency or the gas supplier.



If this unit will be installed in a beauty salon or other location where hair spray or aerosols will be used, locate the unit in a separate area that is supplied with fresh air from outdoors.



Do not use hair spray or spray detergent in the vicinity of the heater.



[When supplying combustion air from the indoors]

Check the air supply opening for dust or obstructions.



(Continued)



Prohibited

Do not allow small children to play unsupervised in the bathroom.
Do not allow small children to bath unsupervised.



Don't touch with a wet hand.



Electric Shock.

Do not touch the power cord with wet hands.



Be sure to do.

Consult the nearest Noritz agent if the water heater location needs to be changed.



Don't disassemble the equipment.

Contact a qualified service technician for any necessary repairs, service or maintenance.



Be sure to do.

Contact Noritz before using with a solar pre-heater.

California Proposition 65 lists chemical substances known to the state to cause cancer, birth defects, death, serious illness or other reproductive harm. This product may contain such substances, be their origin from fuel combustion (gas, oil) or components of the product itself.

The gas conversion kit shall be installed by a qualified service agency in accordance with the manufacturer's instructions and all applicable codes and requirements of the authority having jurisdiction. The information in the instructions must be followed to minimize the risk of fire or explosion or to prevent property damage, personal injury, or death. The qualified service agency is responsible for the proper installation of this kit. The installation is not proper and complete until the operation of the converted appliance is checked as specified in the manufacturer's instructions supplied with the kit.



CAUTION



Ground.

Be sure to electrically ground the unit.



Be sure to do.

Keep power cord free of dust.



Prohibited

Do not use the water heater for other than hot water supply, shower and bath.



Prohibited

Do not use a broken or modified power cord. Do not bind, bend or stretch power cords. Do not scratch, modify, or subject them to impact or force.



Be sure to do.

To prevent burns or scalding, turn off the power button and wait until the equipment cools before performing maintenance.



Prohibited

Do not turn off the water heater while someone is bathing.



Prohibited

Do not cover the water heater and the exhaust vent terminal, store trash or debris near it, or in any way block the flow of fresh air to the unit.



Prohibited

Do not install in locations where excessive dust or debris will be in the air.



Don't touch.

Do not touch the exhaust vent pipe and exhaust vent terminal during or immediately after operation of the water heater.

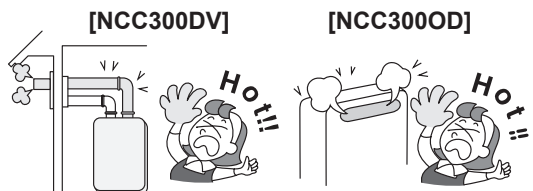

Prohibited

Do not use condensate, discharged from the drain pipe, for drinking or for consumption by animals.

Important Safety Information-3

CAUTION

Do not drink water that has been inside the unit for an extended period of time. Do not drink the first use of hot water from the unit in the morning.

Clean the filter on the water inlet as frequently as required by the quality of your local water.

Keep the area around the unit clean.

If boxes, weeds, cobwebs, cockroaches etc. are in the vicinity of the unit, damage or fire can result.

Do not install the equipment where the exhaust will blow on walls or windows.

If the water supply is in excess of 12 grains per gallon (200 mg/L) of hardness, acidic or otherwise impure, treat the water with approved methods in order to ensure full warranty coverage. (→ p.37)

Problems resulting from scale formation are not covered by the warranty.

Check ignition during use and extinction after use.

Do not run water through the unit when unit is not on.

When discharging hot water, make sure the unit is ON. If water is run through the unit with the unit OFF, water may condense inside the unit and cause incomplete combustion or damage to the internal electrical components.

For single-handle fixtures, you'd turn the handle to the left.

This unit is only approved for installation up to 4500 ft. (1350m) above sea level.

For installations at higher elevations, contact Noritz America for Instructions.

Do not disassemble the remote controller.

Do not use benzene, oil or fat detergents to clean the remote controller.

This may cause deformation.

Do not get the remote controller wet.

It is not water resistant, water can cause damage.

Do not splash water on the remote controller. Do not expose the remote controller to steam.

Do not locate the remote controller near stoves or ovens, this may cause damage or failure.

Preventing damage from freezing (→ p.32)

Damage can occur from frozen water within the device and pipes even in warm environments. Be sure to read below for appropriate measures. Repairs for damage caused by freezing are not covered by the warranty.

Take necessary measures to prevent freezing of water and leakage of gas when leaving the unit unused for long periods of time. (→ p.33)

If it is snowing, check the exhaust vent terminal for blockage.

Do not use parts other than those specified for this equipment.

Contents

Important Safety Information	2
Contents.....	7
Overview of Condensing Tankless Gas Water Heater	8
RC-9018M Operation Overview.....	9
General Parts	
Main Unit.....	11
Remote Controller.....	12
System Check.....	14
Initial Operation.....	16
For All Systems	
Clock Adjustment.....	17
Using the Water Heater.....	18
Setting Hot Water Temperature.....	19
Automatic Water Heater “ON” or “OFF” Operation	20
Locking the Remote Controller.....	22
Customizable Settings <Misc settings>.....	23
For System [Rcrc]	
Enabling Automatic Recirculation Operation.....	26
Manually Starting Recirculation Operation	27
Setting the Recirculation System Operation Timer	28
Single Water Heater Only	
Flow Meter Alarm	30
Preventing Damage from Freezing.....	32
Regular Maintenance	35
Troubleshooting	38
Follow-up Service	43
Specifications.....	46
Default Settings.....	47

Overview of Condensing Tankless Gas Water Heater

This water heater is a high efficiency, fully condensing appliance. Unlike a traditional tankless water heater, a condensing type captures heat from the exhaust gas and uses it to preheat the incoming cold water as it passes through the secondary heat exchanger as illustrated below.

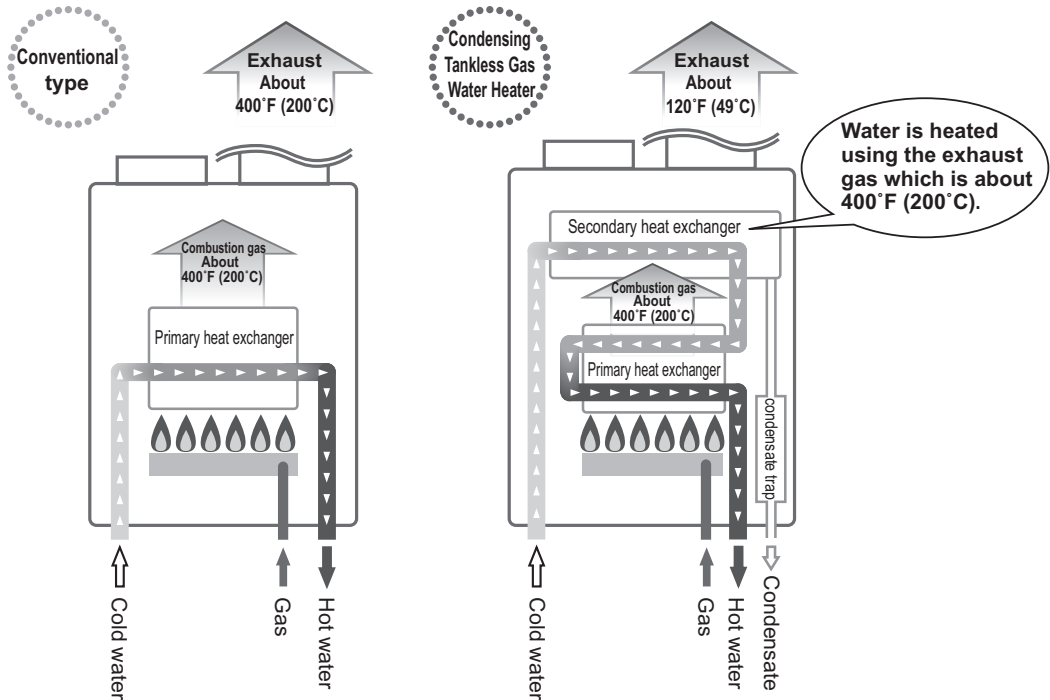

The condensing tankless gas water heater discharges condensate.

When heat from the exhaust gas is collected within the secondary heat exchanger, condensation occurs from moisture in the exhaust gas and the resulting water is discharged from the drain pipe (approx. 3 gallons/hour (11.3 liters/hour) maximum). It is not a water leak. Do not plug or block the drain line as it must always be allowed to freely flow.

Note : The condensate discharged is acidic with a pH level of approximately 2-3.

A condensate neutralizer may be required by local code prior to disposal.

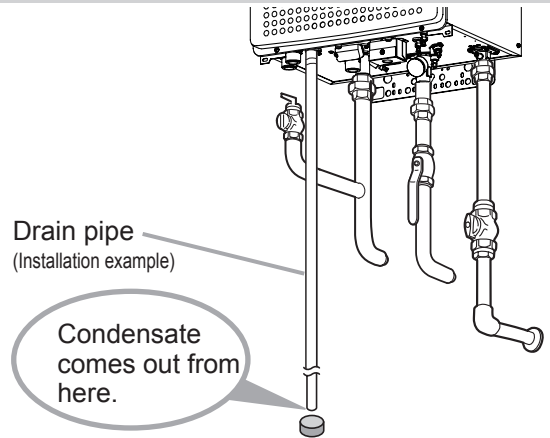

The condensing tankless gas water heater tends to show white steam.

After the exhaust gas passes through the secondary heat exchanger, the low temperature and high moisture content tends to produce steam at the vent discharge terminal. This is a normal occurrence.

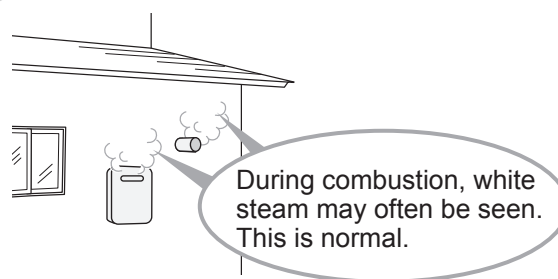

RC-9018M Operation Overview - 1

Basic operation

It is possible to automatically turn the water heater "ON" or "OFF".

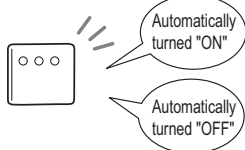

☞ p.20

It is possible to lock remote controller operation.

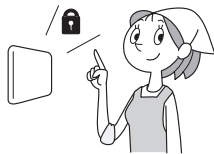

☞ p.22

[For recirculation systems (System [Rcirc])]
It is possible to circulate hot water only during preferred times of day.

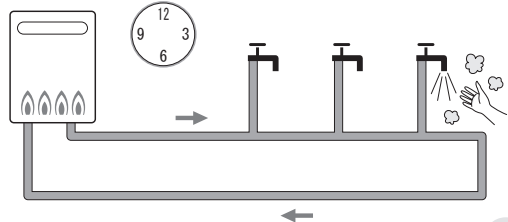

☞ p.28

[When using only one water heater:]
It is possible to set the remote controller to alert the user when the bathtub has reached a preset fill volume to prevent overflowing.



☞ p.30

Power Saving Mode

The initial setting is set to "Powersave dsply : No-1"

If you set "Powersave dsply" to "Yes" (☞ p.23), unnecessary power consumption by the remote controller is prevented. If approximately ten minutes pass without using hot water or without pressing a button, the display of the remote controller turns off.

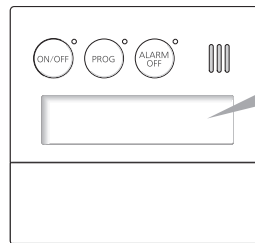

The display turns off (operation is "ON")

- * If you use hot water or press a button, "Powersave dsply" is released.
- * If you press the PROG button only once, "Powersave dsply" is released and the automatic program function will operate.
- * If the setting temperature is set to 125°F/55°C or more, "Powersave dsply" will not function to prevent accidental scalding.
- * If "Recirc" is operating, "Powersave dsply" will not function.

This setting is adjustable ☞ p.23

RC-9018M Operation Overview - 2

User Preferences

The remote controller can be customized based on the preference of the user in the following ways:

The set temperature can be restricted to a maximum level to prevent high temperature settings from being selected.

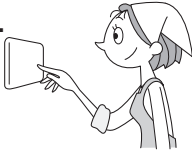

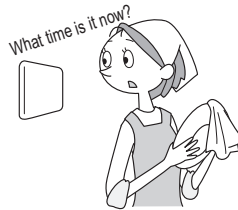

Adjusting the Maximum Output Temperature  p.23

The clock display can be shown even though the power ON/OFF button is set to "OFF".

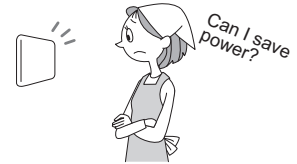

The remote controller display can be turned off to save power.



Power Saving Modes  p.23

The brightness of the remote controller can be adjusted for better visibility.



Remote Controller Display Brightness Settings  p.24

The remote controller can be muted so that it does not emit a tone when a button is pressed.

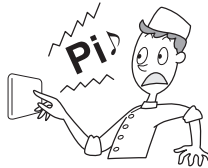

Muting the Remote Controller  p.24

The remote controller can be muted so that it does not emit a tone when an error occurs.

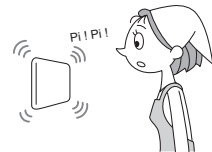

Error Tone Settings  p.24

>> Additional Settings

▶ Draining the water heater (freeze prevention).

 p.25 "Draining the Water Heater"

▶ Restoring default remote controller settings.

 p.25 "Restoring Default Settings"

General Parts -1

Main Unit

[NCC300DV (GQ-C5032WZ-FF US)]
Indoor Wall Mounted, Power Vent/Sealed Model

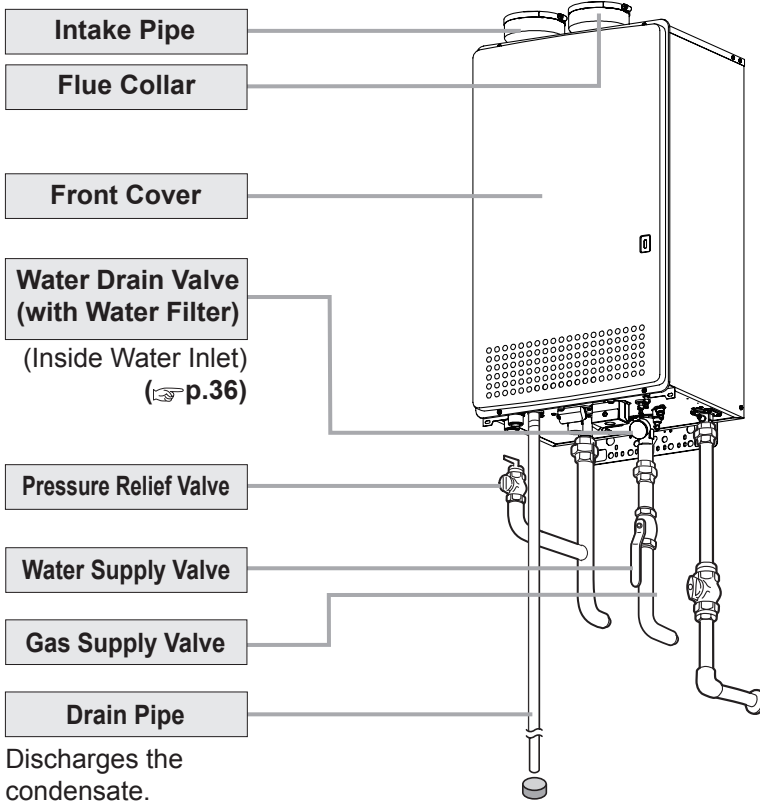

[NCC300OD (GQ-C5032WZ US)]
Outdoor Wall Mounted, Power Vented Model

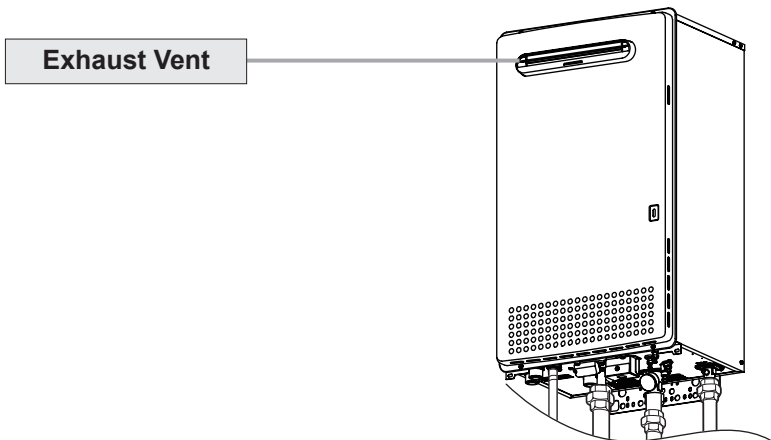

* The above illustration shows an example of installation.
The exact installation configuration may be slightly different.

General Parts -2

Remote Controller (RC-9018M)

The remote controller will emit a tone when a button is pressed.

Prog Button / Indicator (Red)

Activates the automatic water heater power "ON" or "OFF" setting as determined by the user selected schedule. (☞p.21)

Power ON /OFF Button / Indicator (Green)

For turning the water heater on/off.

Alarm Off Button / Indicator (Red)

Stops the tone that is emitted when an error occurs. (☞p.42)

Speaker

Display Screen

(☞Next page)

Menu Button

- * Use to change system settings or to return to the home screen.
- * If you press the menu button and press the temperature setting buttons, **Sys monitor** is sometimes displayed, however, do not use this mode as it meant for installation or service personnel only.

Status Button

Check the status of the system or the number of installed units (☞p.14)

Remote Controller Part Number

The part number is printed on the surface of the cover.

Cover shown in the open position.

Lock Button

Locks remote controller operation. (☞p.22)

Back Button

Returns to the previous screen while making system settings or checking status.

Enter Button

Confirms changes made by the user.

Hot Water Temperature Setting Buttons

For setting the hot water temperature (☞p.19), the flow meter alarm, and other settings.

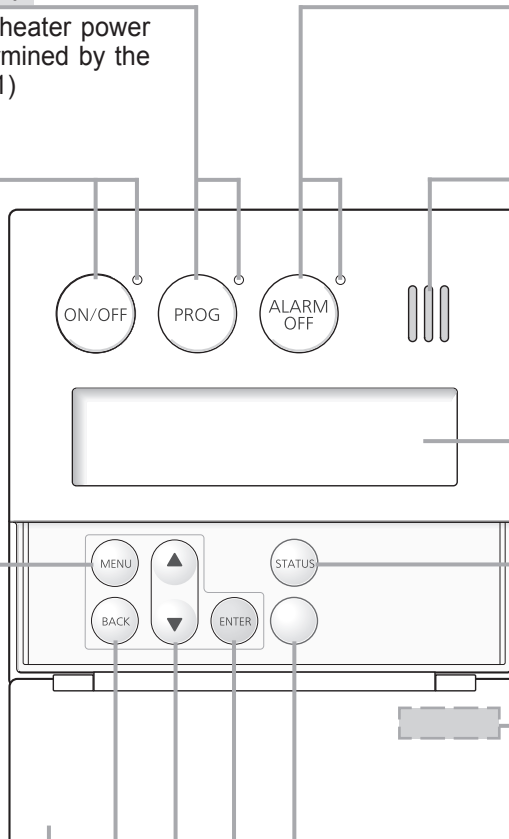

● Screen Display ●

- * The screen display shown below is for illustration purposes only. The actual display will vary depending on how the water heater is being used.
- * After a button is pressed, the display will gradually become darker to prevent unnecessary power consumption by the remote controller.

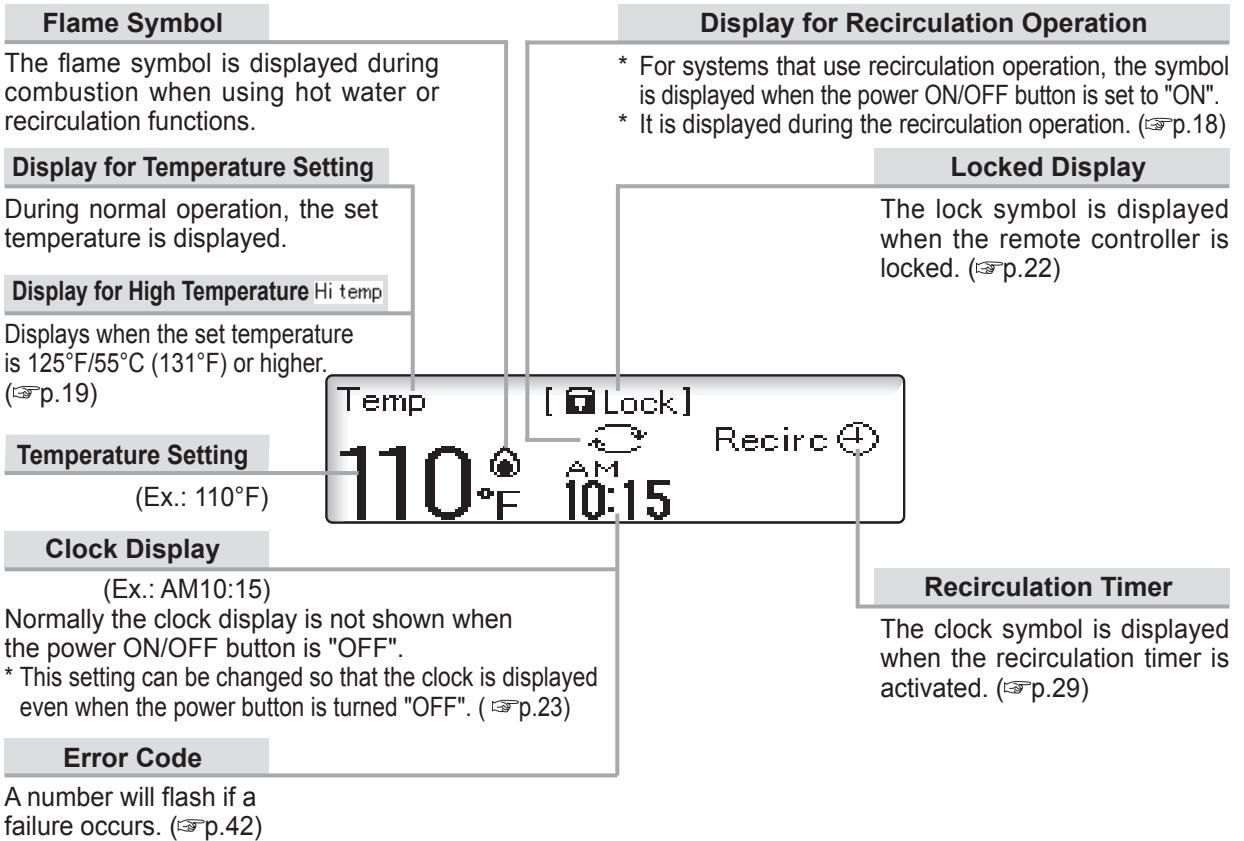

Note: As shipped from the factory, the remote controller is set to display in °F and gallons. To adjust the display to °C and liters, refer to the Installation Manual.

● What is the home screen? ●

The home screen is displayed when the  button is "ON". Normally, the hot water temperature and the clock, etc. are displayed.





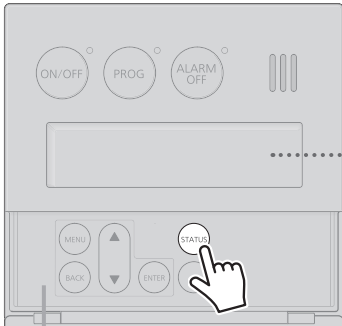

System Check

If you press the  button, you can check the status of the system

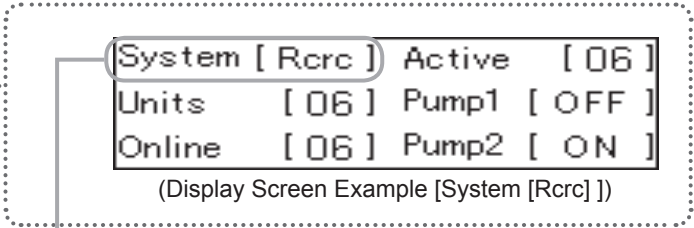

Cover shown in the open position.



System Displayed on the Remote Controller	System Description
System [Std]	Water heater only operation.
System [Rcrc]	<ul style="list-style-type: none"> * Water heater and recirculation operation. * During recirculation operation, hot water is always circulated in the piping to provide instant hot water when a fixture is opened. <p>[If you set the  button to "ON",  is displayed. (If "synchro ON/OFF" is set to "ON". (p.26))]</p>
System [Tank]	<ul style="list-style-type: none"> * Water heater combined with a storage tank operation. * If a recirculation system is also installed, hot water is always circulated in the piping to provide instant hot water when a fixture is opened. <p>[If you set the  button to "ON",  is displayed.]</p>

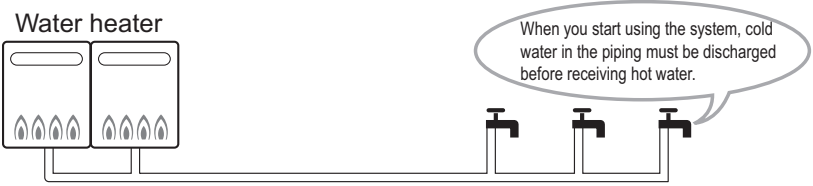
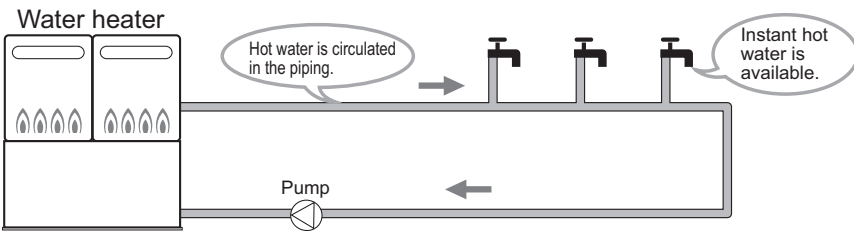
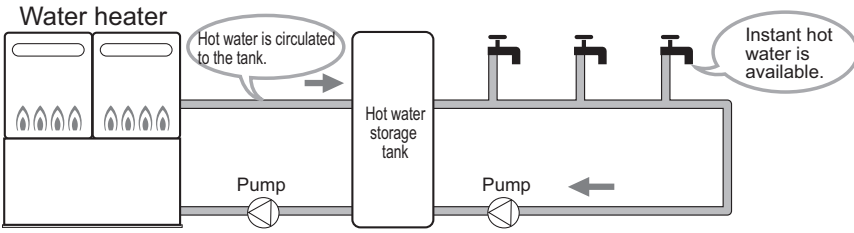

Depending on the configuration of your system, not all functions may be used.

<p align="center">General System Diagram</p> <p>* The number of water heaters, fixtures, and pumps will vary depending on the configuration of the hot water system.</p>	<p align="center">Applicable Remote Controller Functions</p>
	<p align="center">Functions other than those shown on pages 26 to 29 can be used.</p>
	<p align="center">All functions can be used.</p>
	<p align="center">Functions other than those shown on pages 26 to 31 can be used.</p>

Initial Operation

Before the first use of your water heater, do the following:

Follow steps **1 through 4.**

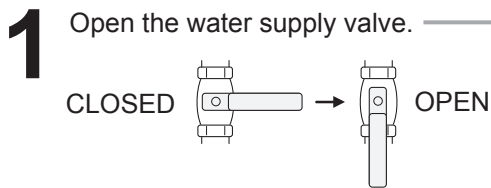

2 Open a hot water fixture/faucet to confirm that water is available, and then close the fixture/faucet again.

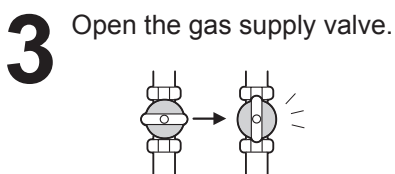
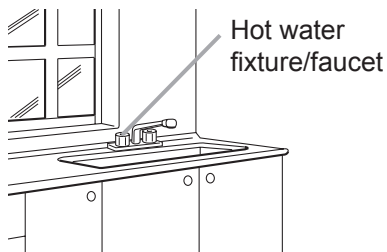

4 Turn on the power.
Do not touch with wet hands.

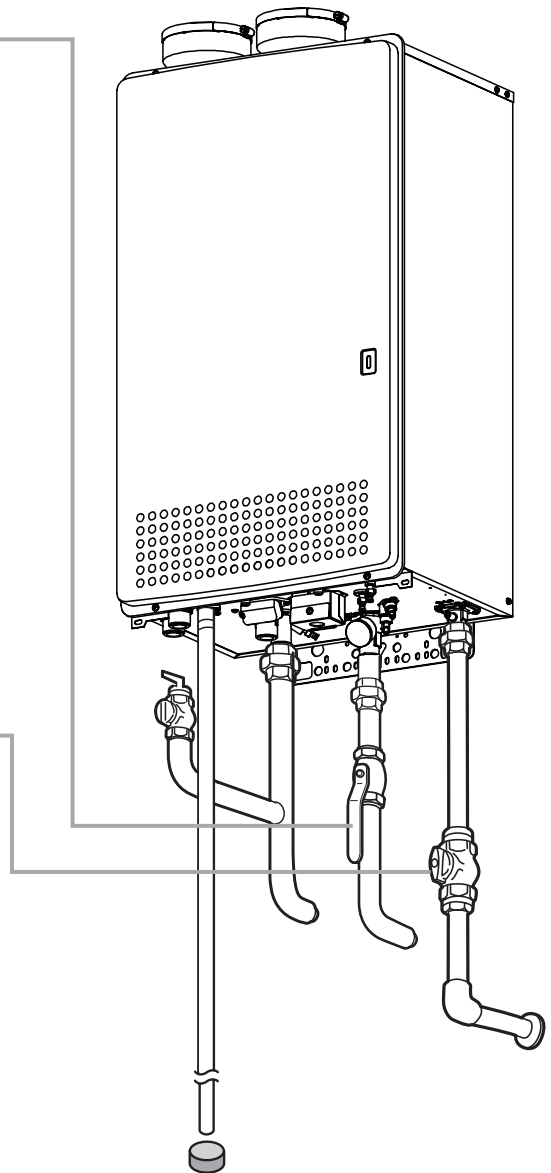





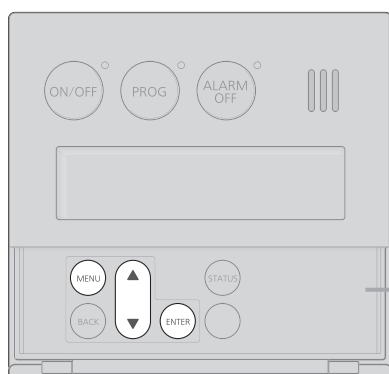

(Ex. NCC300DV (GQ-C5032WZ-FF US))

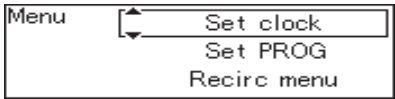

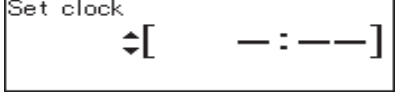
For All Systems Clock Adjustment

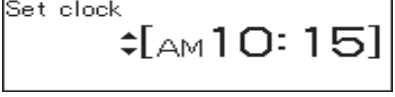
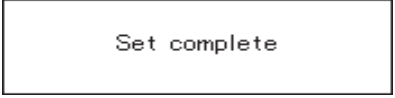

Cover shown in the open position.

Operation	Screen Display	Description
1 Press the  button inside the cover.		* This adjustment can be made regardless of whether the  button is ON/OFF.
2 Press the  button.		
3 <ol style="list-style-type: none"> Use the  buttons to reset the clock. Press the  button to complete the clock setting. 	<ol style="list-style-type: none">  (Ex: AM10:15)  <p style="text-align: center;">▼ The screen returns to the previous screen.</p>	* The time changes in 1-minute increments with each press of the button, and then in 10-minute increments if the button is kept pressed down. * If the display is left untouched for approximately 20 seconds without pressing the  button, the setting will be completed. When the  button is turned ON, the home screen will be restored.

* In the event of a power outage or after disconnecting power to the water heater, when power is restored, the clock on the display screen will show " - : - - " and the clock will need to be reset.

* Normally, when the  button is turned OFF, the clock display disappears, but it is possible to display the clock when the  button is turned OFF by changing a setting. (p.23)

Using the Water Heater





* If System [Tank] is displayed, hot water will be discharged at the temperature of the storage tank.

Operation	Screen Display	Description
-----------	----------------	-------------

1  button is "ON".

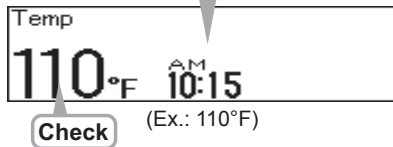
For systems with recirculation operation,  is displayed here.



- * The  indicator is lit.
- * The previously set hot water supply temperature is shown.
[For systems with recirculation operation]
- * If you set the  button to "ON", recirculation operation is automatically started. (If "Synchro ON/OFF" was set to "ON". (p.26))
- * The setting temperature displayed may vary from the actual temperature at the fixture depending on conditions such as season or length of piping.

2 Turn on hot water.

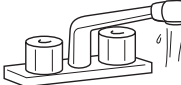

● Turn off the hot water

Turn off hot water.

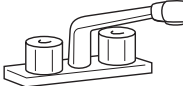

* During operation, the symbol  may be continuously lit.

DANGER



To prevent scalding :
Hot Water Heater temperatures over 125°F (52°C) can cause severe burns instantly or death from scalding.

- Children, disabled and elderly are at the highest risk of being scalded. Feel water temperature before bathing or showering. Temperature limiting valves are available, ask a professional person.
- When setting the unit to 125°F (55°C in °C mode) or higher, "Hi temp" will flash for 10 seconds and emit a tone as a high temperature warning.
- Take caution when using the unit again after setting to 125°F (52°C) or higher. Always check the set temperature before use.
- Do not allow anyone to change the water temperature while hot water is running.

For All Systems

Setting Hot Water Temperature

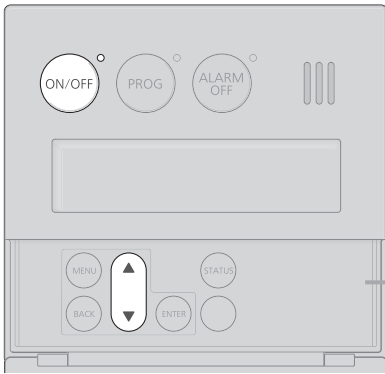

Cover shown in the open position.



* If System [Tank] is displayed, hot water will be discharged at the temperature of the storage tank.

Operation	Screen Display	Description
1 button is "ON".		* The indicator is lit. * The previously set hot water supply temperature is shown.
2 Set the temperature using the buttons inside the cover.		

● Temperature Setting Options ●

■ When using °F mode: (°F: The temperature settings below are examples. The temperature setting necessary depends on the usage, the length of piping and the time of year.)

100	105	110	115	120	125	130	135	140	145	150	160	170	185
Washing dishes, etc.	Shower, hot water supply, etc.				High temperature								

*Initial factory setting is 110°F

■ When using °C mode: (°C (°F): The temperature settings below are examples. The temperature setting necessary depends on the usage, the length of piping and the time of year.)

37 (99)	38 (100)	39 (102)	40 (104)	41 (106)	42 (108)	43 (109)	44 (111)	45 (113)	46 (115)	47 (117)	48 (118)	50 (122)	55 (131)	60 (140)	65 (149)	70 (158)	75 (167)	80 (176)	85 (185)
Washing dishes, etc.	Shower, hot water supply, etc.										High temperature								

*Initial factory setting is 40°C (104°F)

< Display when high temp is set >

Blinks for approximately 10 seconds → Lit.

If fixtures incorporate mixing valves, set the temperature higher than usual.

* For applications that occasionally require a higher temperature setting, locate the remote controller in a convenient location.

* Consult local codes for minimum operating temperatures.

Note : An error code will be displayed when this water heater detects scale build-up in the heat exchanger. The error code may be more frequently displayed when the unit is set to a high temperature. (125°F or higher) Noritz recommends that water temperature is set as low as possible to prevent scale build-up in the heat exchanger.

- Hot water temperatures shown are approximate and may differ from the actual temperature at the fixture depending on external factors such as the season and length of piping in the system.
- When low temperatures are set (for washing dishes, etc.), if the incoming water temperature is already quite high, it may be difficult to ensure the outgoing water temperature is as per the setting.
- Please check the temperature displayed before using any hot water. Be especially careful using hot water after the set temperature has been changed.
- When the hot water temperature is adjusted using thermostat controlled water mixing valves, set the temperature on the remote controller approximately 20°F (10°C) higher than the required temperature to ensure the appropriate fixture temperature.

Automatic Water Heater "ON" or "OFF"

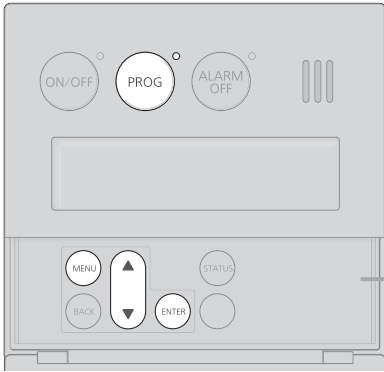

Cover shown in the open position.



- * If you set the time to turn "ON" or "OFF" the button, the button is automatically turned "ON" or "OFF" at the set time every day by just turning the button "ON".
- * It is also possible to set only "ON" or "OFF" operation.
- * For recirculation systems, circulation is started or stopped according to the button condition, "ON" or "OFF".

Set the time to turn "ON" or "OFF" the button automatically

Operation	Screen Display	Description
-----------	----------------	-------------

This example describes setting the "ON time" and "OFF time" to 10:00 am and 8:00 pm, respectively.

- Preparation**
1. Check that the current time is properly set. (Setting the time p.17)
 2. Check the button is set to "OFF"

- 1**
- 1) Press the button inside the cover, Select "Set PROG" using the buttons.
 - 2) Press the button.

1) Menu
 Set clock
 Set PROG
 Recirc menu

2) Start End
 --:-- ~ --:--

- * You can set the time regardless if the button is "ON" or "OFF".
- * The previously set "Start time" and "End time" are displayed.

- 2**
- 1) Set the ON time to "AM10:00" using the buttons.
 - 2) Press the button to complete the setting.

1) Start End
 AM10:00 ~ --:--

2) Start End
 AM10:00 ~ --:--

- * The time changes in 10-minute increments with each press of the button, and then in 1-hour increments if the button is kept pressed down.
- * If the previous setting is OK, press the button without setting "Start time".
- * If you do not want to set the "Start time", select "- : -" (located between AM 11:50 and PM 0:00 settings).

- 3**
- 1) Set the OFF time to "PM8:00" using the buttons.
 - 2) Press the button to complete the setting.

1) Start End
 AM10:00 ~ PM 8:00

2) Set AM PM
 Reset 10:00 ~ 8:00
 Confirm?

- * The time changes in 10-minute increments with each press of the button, and then in 1-hour increments if the button is kept pressed down.
- * If the previous setting is OK, press the button without setting "End time".
- * If you do not want to set the "End time", select "- : -" (located between AM 11:50 and PM 0:00 settings).

Operation

Hint for operation Following this procedure allows for automated control of water heater operation without user interaction.
 * The setting time shown on the display of the remote controller is for example purposes only.

■ **Ex. 1: Both "ON" and "OFF" functions are automated.**

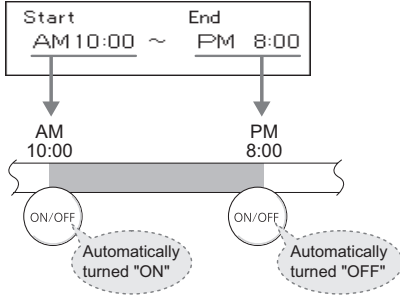

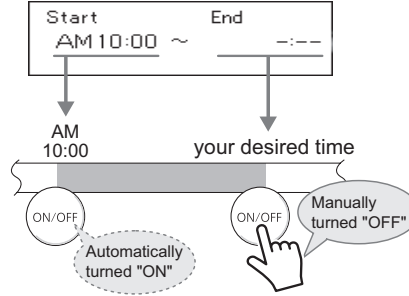

■ **Ex. 2: Only "ON" function is automated.**



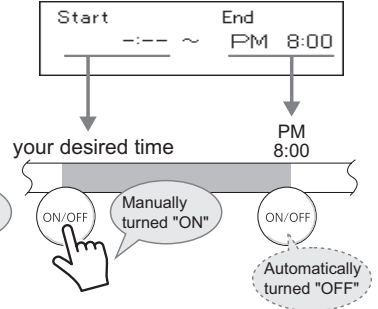

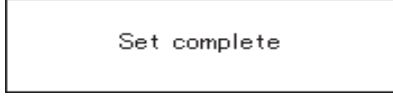
■ **Ex. 3: Only "OFF" function is automated.**

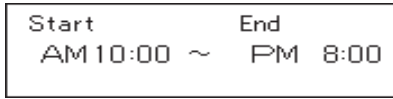

Operation	Screen Display	Description
<p>4 Check "Set" is selected, and then press  button to confirm all settings.</p>		<p>* If you do not press , the time setting is not completed.</p> <p>* If you want to change "ON/OFF time", select "Reset" and then press the , return to step 2.</p>

Activate Automatic Operation

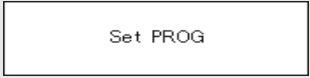
Operation	Screen Display	Description
<p>1  button is "ON".</p>	 (Display Example)	<p>* You can activate automatic operation regardless if the  button is "ON" or "OFF".</p> <p>*  indicator is lit when activated.</p> <p>* "Start time" and "End time" will be displayed upon activation.</p> <p>* If both the "Start time" and "End time" are set to "-:--", the alarm sounds "Pi Pi Pi" and</p>  is displayed.

● To Deactivate Automatic Operation

<p> button is "OFF".</p>	<p>* The  indicator is unlit.</p>
---	--

- * If the  button is not set to "OFF", the water heater will automatically turn "ON" or "OFF" at the set times.
- * If there is a power failure or power is disconnected to the water heater, automatic operation will be deactivated.



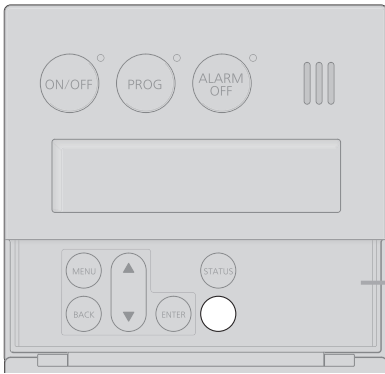











Locking the Remote Controller



Cover shown in the open position.



By locking the remote controller, the settings cannot be accidentally changed if a button is pressed by mistake.

Operation	Screen Display	Description
<p>1 Press and hold  button for approximately 2 seconds to lock the remote controller.</p>	<div style="border: 1px solid black; padding: 5px; text-align: center;"> <p>Lock complete</p> <p>[PROG]  [MENU] </p> <p>[Temp] </p> </div>	<ul style="list-style-type: none"> * The operation can be locked regardless if the  button is "ON" or "OFF". * The operations of , , and  buttons are locked. * Approximately 3 seconds after locking the remote controller, the display will return to the previous screen.
<p>If you press these buttons</p> <div style="display: flex; align-items: center; gap: 10px;">    </div> <p>while the remote controller is locked, the "Locked" screen will appear.</p>	<div style="border: 1px solid black; padding: 5px; text-align: center;"> <p>Locked</p> <p>[PROG]  [MENU] </p> <p>[Temp] </p> </div>	<ul style="list-style-type: none"> * Approximately 3 seconds after the "locked" screen appears, the display will return to the previous screen.

● To Unlock the Remote Controller

Press and hold  button for approximately 2 seconds to unlock the remote controller.

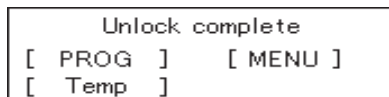

* Approximately 3 seconds after unlocking the remote controller, the display will return to the previous screen.

Customizable Settings <Misc settings> -1

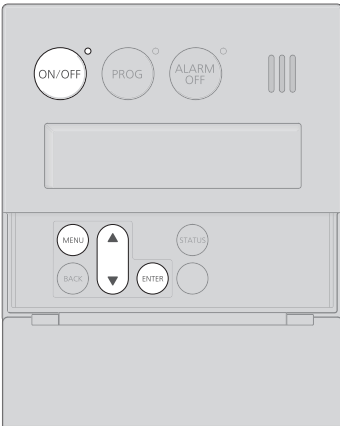

Adjusting the Maximum Output Temperature.

The maximum output temperature can be limited to prevent discharging hot water at too high of a temperature.

- 1 Press the **ON/OFF** button is "OFF".
- 2 Press the **MENU** button inside the cover, Select **Misc settings** using the **↑/↓** buttons.
Press the **ENTER** button.
The "Misc settings" screen appears.
- 3 Select **Max set temp** using the **↑/↓** buttons, and then press the **ENTER** button.
- 4 Change the setting using the **↑/↓** buttons.

Max set temp
↔ [185 °F]

(Ex: 185°F)

[For Fahrenheit (°F)]
 100 - 150°F (In 5°F intervals),
 160°F, 170°F, 185°F
 [For Celsius (°C)]
 37 - 48°C (In 1°C intervals),
 50 - 85°C (In 5°C intervals)

(Initial setting=185°F / 85°C)

Setting completed

Display Screen Power Saving Mode [powersave dsply]

To conserve power consumption by the display, it can be turned off completely or set to only display the clock when the power ON/OFF button is turned "OFF".

- 1 Press the **MENU** button inside the cover, Select **Misc settings** using the **↑/↓** buttons.
Press the **ENTER** button.
The "Misc settings" screen appears.
- 2 Select **Powersave dsply** using the **↑/↓** buttons, and then press the **ENTER** button.
- 3 Change the setting using the **↑/↓** buttons.

Powersave dsply (Clock hidden)
↔ [No-1]

(Ex: No-1)

Yes: the display will turn off and the clock will not be displayed when the power ON/OFF button is turned "OFF".

No-1: the display will not turn off and the clock will not be displayed when the power ON/OFF button is turned "OFF".

No-2: the display will not turn off and the clock is displayed when the power ON/OFF button is turned "OFF".

(Default setting=No-1)



Setting completed



To change other settings, select the option and press the **ENTER** button.

To return to the home screen, press the **MENU** button or let it sit for approximately 20 seconds.

Adjusting the brightness of the display screen when the remote controller is turned on.

The display screen can be brightened or darkened or the backlight can be turned off completely.

- 1 Press the  button inside the cover, Select **Misc settings** using the  buttons.
Press the  button.
The "Misc settings" screen appears.

- 2 Select **Brightness** using the  buttons, and then press the  button.

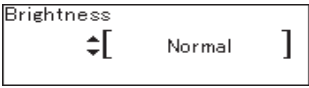
- 3 Change the setting using the  buttons.

(Ex: Normal)



Dark / Dim / Normal / Bright



(Default setting=Normal)

Setting completed

Muting the remote controller.

The remote controller can be muted so that it does not emit a tone when a button is pressed.

- 1 Press the  button inside the cover, Select **Misc settings** using the  buttons.
Press the  button.
The "Misc settings" screen appears.

- 2 Select **Touch sound** using the  buttons, and then press the  button.

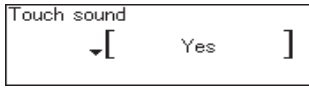
- 3 Change the setting using the  buttons.

(Ex: Yes)



Yes / No



(Default setting=Yes)

Setting completed

<System dependent option> Error Tone Settings.

The remote controller can be muted so that it does not emit a tone when an error occurs.

- 1 Press the  button inside the cover, Select **Misc settings** using the  buttons.
Press the  button.
The "Misc settings" screen appears.

- 2 Select **Error alarm** using the  buttons, and then press the  button.

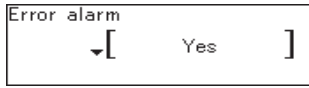
- 3 Change the setting using the  buttons.

(Ex: Yes)

Yes / No

(Default setting=Yes)





Setting completed



To change other settings, select the option and press the  button.

To return to the home screen, press the  button or let it sit for approximately 20 seconds.

Draining the Water Heater.

(☞ Refer to page 33 for details.)

- 1  button is "OFF".
- 2 Press the  button inside the cover, Select **Misc settings** using the  buttons.
Press the  button.
The "Misc settings" screen appears.

- 3 Select **Drain water** using the  buttons, and then press the  button.

- 4 Select "YES" using the  buttons.

No	Drain water
Yes	now ?

Press the  button.

Follow the drain procedures in the manual





Drain the water heater following the procedures described on page 33.



To stop draining water from the water heater

If you press the  button again when "Drain water" and "Operating" are alternately displayed following steps 2 to 3, the drain function will stop.

Restoring Default Settings.

Select settings can be restored to the factory default conditions. See items marked with a ★ in the "Default Settings" section (☞ p.47).

- 1  button is "OFF".
- 2 Press the  button inside the cover, Select **Misc settings** using the  buttons.
Press the  button.
The "Misc settings" screen appears.

- 3 Select **Default all settings** using the  buttons, and then press the  button.

- 4 Select "YES" using the  buttons.

No	Default all settings
Yes	now ?

Press and hold the  button for approximately 5 seconds.

Reset complete

Setting completed



To change other settings, select the option and press the  button.

To return to the home screen, press the  button or let it sit for approximately 20 seconds.

For System [Rcirc]



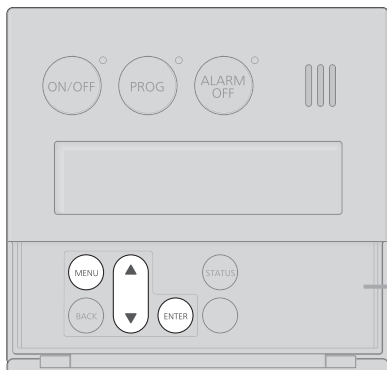





Enabling Automatic Recirculation Operation



Cover shown in the open position.



- * To check system status. (→p.14)
- * When “synchro ON/OFF” is set to “Yes”, recirculation can be activated automatically.
- * To change “synchro ON/OFF” from “Yes” to “No”, follow the same procedure as described below.

Operation	Screen Display	Description
<p>1</p> <p>1) Press the  button inside the cover, Select "Recirc menu" using the  buttons.</p> <p>2) Press the  button.</p>	<p>1) Menu Set clock Set PROG ← Recirc menu</p> <p>2) Recirc ← Synchro ON/OFF Menu Recirc on/off Recirc timer</p>	<p>* This adjustment can be made regardless of whether the  button is ON/OFF.</p>
<p>2</p> <p>Select "Synchro ON/OFF" and press the  button.</p>	<p>Synchro ON/OFF ↑ [No]</p>	
<p>3</p> <p>1) Press .</p> <p>2) Press the  button.</p>	<p>1) Synchro ON/OFF ↓ [Yes]</p> <p>2) Set complete</p>	<p>* If the display is left untouched for approximately 20 seconds without pressing the  button, the setting will be completed, and when the  button is turned ON, the home screen will be restored.</p>

The screen returns to the previous screen.

For System [Rcirc]

Manually Starting Recirculation Operation

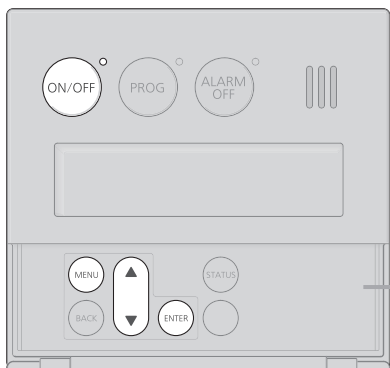

Cover shown in the open position.



Recirculation operation can be manually stopped or started using this procedure.

Operation	Screen Display	Description
<p>1</p> <p>1) Press the button inside the cover, Select "Recirc menu" using the buttons.</p> <p>2) Press the button.</p>	<p>1) </p> <p>2) </p>	<p>* You can set this function if the button is "ON".</p>
<p>2</p> <p>1) Select "Recirc on/off" using the buttons.</p> <p>2) Press the button.</p>	<p>1) </p> <p>2) </p> <p>[Display when recirculation is set to "ON"]</p> <p style="text-align: center;">▼</p> <p>The screen returns to the previous screen.</p>	<p>* If the display is left untouched for approximately 20 seconds without pressing the button, the setting will be completed.</p> <p>[Display when the recirculation is set to "OFF"]</p> <div style="border: 1px solid black; padding: 5px; width: fit-content; margin: 0 auto;">Stopping recirc operation</div>

Setting the Recirculation System

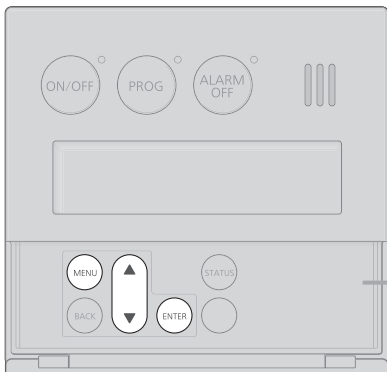

Cover shown in the open position.



- * With the recirculation operation timer set, hot water will be automatically circulated in the hot water pipes. Even with this function activated, it may take several minutes for hot water to be completely circulated through the plumbing system. Set the timer to activate the recirculation system prior to the first use of hot water to ensure hot water is instantly available.
- * Multiple recirculation time periods can be set.
- * Until the timer is deactivated (p.29), the recirculation system will operate daily at the set times.
- * When the recirculation system is turned "OFF" by the timer, the water heater will still remain "ON" and can be used normally.

Operation	Screen Display	Description
-----------	----------------	-------------

This example describes setting the recirculation system to operate between 5:00 am - 8:00 am.













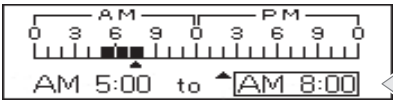

Preparation Check that the current time is properly set.
(Setting the time p.17)

<p>1</p> <p>1) Press the MENU button inside the cover, Select "Recirc menu" using the ▲ buttons.</p> <p>2) Press the ENTER button.</p>	<p>1) Menu Set clock Set PROG Recirc menu</p> <p>2) Recirc Menu Synchro ON/OFF Recirc on/off Recirc timer</p>	<p>* You can set the timer regardless if the ON/OFF button is "ON" or "OFF".</p>
--	---	---

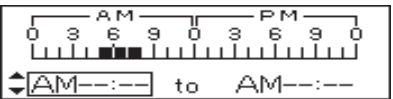
<p>2</p> <p>1) Select "Recirc timer" using the ▲ buttons.</p> <p>2) Press the ENTER button.</p>	<p>1) Recirc Menu Synchro ON/OFF Recirc on/off Recirc timer</p> <p>(Example of a display)</p> <p>2) 0 3 6 9 0 3 6 9 0 AM--:-- to AM--:--</p>	<p>* The previous setting is displayed.</p>
--	--	---

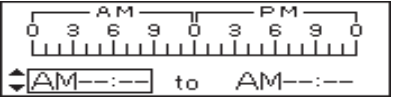
<p>3</p> <p>1) Select "AM5:00" using the ▲ buttons.</p> <p>2) Press the ENTER button to complete the "Start" time setting.</p>	<p>1) 0 3 6 9 0 3 6 9 0 AM 5:00 to AM 6:00</p> <p>2) 0 3 6 9 0 3 6 9 0 AM 5:00 to AM 6:00</p>	<p>* Every time when you press the button, the time changes by one hour.</p> <p>[To keep the current "Start" time] Press the ENTER button without changing the "Start" time, and proceed to step 4.</p> <p>[To add additional time periods to the current setting, or to cancel the previous setting]</p> <p>1) Press the ENTER button without setting "Start" time.</p> <p>2) Press the ENTER button without setting "End" time.</p> <p>3) Follow the procedures "Adding Additional Time Periods" or "Resetting All Time Periods" (p.29).</p>
---	---	---

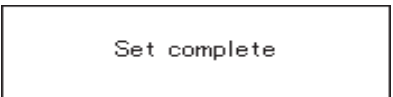
Operation Timer

Operation	Screen Display	Description
<p>4</p> <p>1) Select "AM8:00" using the  buttons.</p> <p>2) Press the  button to complete the "End" time setting.</p> <p><Adding Additional Time Periods></p> <p>1) Select "Add" using the  buttons.</p> <p>2) Press the  button.</p> <p>3) Select the time period following the procedures in Steps 3 to 4.</p> <p><Resetting All Time Periods></p> <p>1) Select "Reset" using the  buttons.</p> <p>2) Press the  button. (All settings are cleared.)</p> <p>3) Adjust the time period following the procedures in Steps 3 to 4.</p>	<p>1)  Here</p> <p>2) </p> <p>1) </p> <p>2) </p> <p>1) </p> <p>2) </p>	<p>* Every time when you press the button, the time changes by one hour. [To keep the current "End" time] Press the  button without changing the "End" time, and proceed to step 5.</p> <p>* You can set multiple operation time periods.</p>
<p>5</p> <p>Press the  button to complete the time settings.</p>	<p></p> <p>▼</p> <p>"Recirc timer" and "Recirc timer on" are alternately displayed on the menu (approximately 10 seconds)</p> <p>▼</p> <p></p> <p>(Example of home screen when the power ON/OFF button is turned "ON")</p>	<p>* The timer will not activate without pressing the  button.</p> <p>* If the time is not set, the time setting screen is displayed (p.17).</p> <p>* Until the timer is deactivated, the recirculation system will operate daily at the set "Start" and "End" times.</p>

● To Cancel the Recirculation System Operation Timer

1) Carry out steps 1 to 2.

2) Select "Cancelled"

using the  buttons.

3) Press the  button.

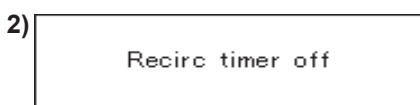
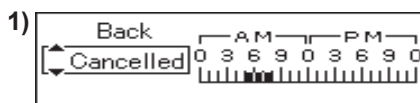

The screen returns to the Recirc Menu.

- * If the  button is "ON", the screen returns to the home screen in approximately 10 seconds.
- * If the timer is deactivated during a recirculation time period, recirculation will continue until it is stopped using the procedure shown on p.27.

Flow Meter Alarm

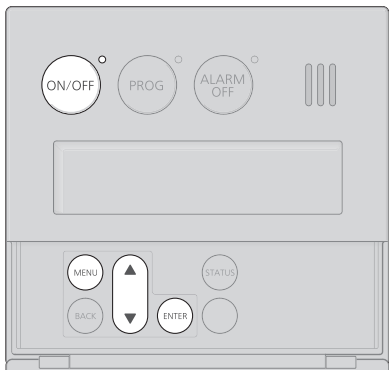

If the flow meter alarm is being used to indicate when a tub is full:

- If any hot water is being used besides what is going into the tub, the alarm will sound before the tub is full.
- If there was water in the tub before the fill began, or if the water is not shut off manually when the alarm sounds, the tub may overflow.
- If there was water in the tub before the fill began, the temperature in the tub after it is full may be different from the temperature setting.

Operation	Screen Display	Description
-----------	----------------	-------------

Preparation

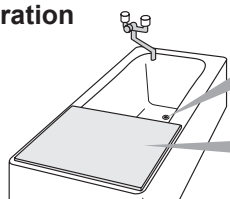

① Confirm that the stopper is closed.

② Close the lid.

* Open the lid closest to the spout to allow for filling.

(Example of bathtub filled with hot water.)

1 button is "ON".

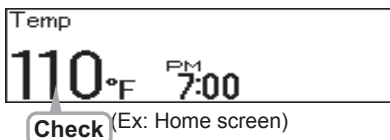

- * The indicator is lit.
- * The current setting temperature is displayed.

2 1) Press the button inside the cover, Select "Flow meter" using the buttons.
2) Press the button.

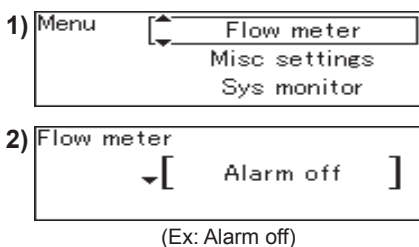

- * The current hot water filling volume is displayed.

3 Adjust the Flow Meter Alarm volume setting
1) Change the volume with to your desired hot water volume.
2) Press the button.

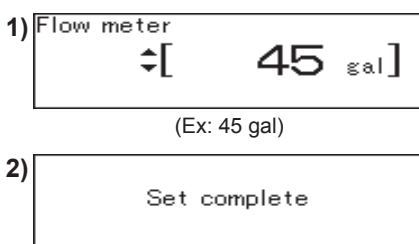

- * The set hot water volume will be stored in memory.
- * The screen returns to the home screen.
- * If the display is left untouched for approximately 20 seconds without pressing the button, the setting will be completed and the home screen will be restored.

● Fill Volume Options ●

10	15	20	25	30	35	40	45	50	55	60	70	80	90	100	Alarm off
															(gal)
40	60	80	100	120	140	160	180	200	220	240	260	300	340	380	Alarm off
															(L)

(Default setting = Alarm off)

Operation	Screen Display	Description
-----------	----------------	-------------

4 Turn on hot water.

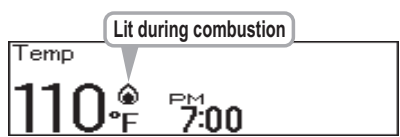



If the hot water temperature has been set so that it does not require mixing, set the mixing valve to its highest setting.

The hot water in the bathtub may become lukewarm if it is mixed with cold water at the fixture.



5 When the bathtub fills with the preset volume of water, an alarm will sound alerting you to shut off the water.



Please turn off hot water faucet

- * Why doesn't the flow meter alarm sound even if the bathtub is filled with water? (→ p.40)
- * The alarm will continue to sound even if the  button is pressed.

Turn off the hot water when the alarm sounds to prevent overflowing.



● Hot Water Filling Temperature Options ●

(°F) : The temperatures settings below are only examples. The temperature setting necessary will depend on the usage, the length of piping and the time of year.

100	105	110	115	120
Warm	Warmer		Hot	

(°C (°F)) : The temperatures settings below are only examples. The temperature setting necessary will depend on the usage, the length of piping and the time of year.

37 (99)	38 (100)	39 (102)	40 (104)	41 (106)	42 (108)	43 (109)	44 (111)	45 (113)	46 (115)	47 (117)	48 (118)
Warm			Warmer			Hot					

* Initial factory setting: 110°F or 40°C (104°F)

- * Although the temperature can be set to 125°F / 50°C or higher, do not set the temperature to 125°F / 50°C or higher as it can cause severe burns instantly or death from scalding.
- * The hot water filling temperature is same as the setting temperature.
- * The setting temperature displayed may vary from the actual temperature at the fixture depending on conditions such as season or length of piping.

Preventing Damage from Freezing-1

CAUTION

- * Damage can occur from frozen water within the device and pipes even in warm environments. Be sure to read below for appropriate measures.
- * Repairs for damage caused by freezing are not covered by the warranty.

Freezing is prevented within the device automatically by the freeze-prevention heater.

Freezing cannot be prevented when the power plug is unplugged. Do not remove the power plug from the wall outlet.

Freezing will be prevented regardless of whether the operation switch is ON or OFF.

- * In normal operation, freezing is prevented within the device automatically unless the outside temperature without wind is below -30°F (-35°C) for NCC300DV (GQ-C5032WZ-FF US) or -4°F (-20°C) for NCC300OD (GQ-C5032WZ US).
 - For model NCC300DV (GQ-C5032WZ-FF US), when supplying combustion air from the indoors, the room temperature must be greater than 32°F (0°C) to prevent freezing and the room inside must not have negative pressure.
- * The freeze prevention heaters will not prevent the plumbing external to the unit from freezing. Protect this plumbing with insulation, heat tape or electric heaters, solenoids, or pipe covers. If there remains a freezing risk, contact the nearest Noritz agent.

Take the measures below for extremely cold temperatures*.

Outside temperature including wind chill factor less than -30°F (-35°C) for NCC300DV (GQ-C5032WZ-FF US) or -4°F (-20°C) for NCC300OD (GQ-C5032WZ US).

- For model NCC300DV (GQ-C5032WZ-FF US), when supplying combustion air from the indoors, the room temperature must be greater than 32°F (0°C) to prevent freezing and the room inside must not have negative pressure.

This method can protect not only the heater, but also the water supply, water piping and mixing valves.

1. Turn off the power.
2. Close the gas supply valve.
3. Open a hot water fixture/faucet, and keep a small stream of hot water running. (0.1 gallon (400cc)/minute or about 0.2" (4mm) thick.)
 - * If there is a mixing valve, set it to the highest level.
 - * When linking multiple units, discharge water equivalent to (0.1 gallon (400cc)/minute per unit.)

4. The flow may become unstable from time to time.

Check the flow 30 minutes later.

* In general, it is not advisable to run water through the unit when it is OFF (p. 6), but in this case freeze prevention is more important.

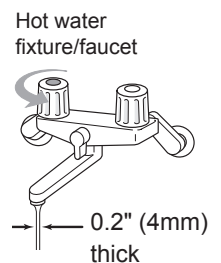

* Remember to set mixing valves and fixtures to their original levels before using the unit again to prevent scalding.

* If there is still a risk that the unit will freeze, drain the unit as shown on the next page.

If water will not flow because it is frozen

1. Close the gas and water valves.
2. Turn off the power button.
3. Open the water supply valve from time to time to check whether water is running.
4. When the water is flowing again, check for water leaks from the equipment and piping before using.

If the heater or the piping is frozen, do not use the heater or it may get damaged.

Preventing Damage from Freezing-2

If the water heater will not be used for a long period of time, drain the water.

Drain the water as follows:



To avoid burns, wait until the equipment cools down before draining the water. The appliance will remain hot after it is turned off.

To prevent damage from freezing, the water heater must be plugged into power at all times. If power is unplugged, drain the water completely from the water heater. Then use an air compressor to remove all water from inside the unit's water piping. It is recommended that Isolation Valves are installed on the water heater, otherwise the water connections will need to be removed to drain the unit completely. Freeze damage due to not draining properly will not be covered under warranty.

Drain water into a bucket to prevent water damage.

Drainage Using the Remote Controller

- 1 (1) ON/OFF button is "OFF".
- (2) Press the MENU button inside the cover, Select Misc settings using the ▲▼ buttons. Press the ENTER button. The "Misc settings" screen appears.
- (3) Select Drain water using the ▲▼ buttons, and then press ENTER button.
- (4) Select "YES" using the ▲▼ buttons,

No Drain water
 Yes now ?

 Press ENTER button.

Follow the drain procedures in the manual

- 2 Close the water supply valve.

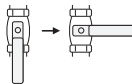

- 3 Fully open all hot water fixtures/faucets.



- 4 Open all drain plugs and drain the water out of the unit.

- 5 When the water is completely drained, replace all drain plugs and close the hot water fixtures/faucets.

- 6 Close the gas valve and disconnect the electrical power supplied to the unit.

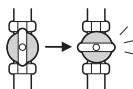

Do not touch with wet hands.

Manual Draining

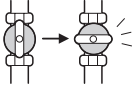
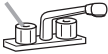
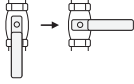
- 1 Close the gas valve.
 
- 2 (1) Turn the power on/off button "On".
 (2) Turn and leave open the hot water fixtures/faucets for more than 2 minutes and close.
 
 - * If multiple units are being used, drain two minutes for each unit.
 - * An 11 Error Code may appear on the remote controller. This is not a malfunction of the unit. Do not turn Power ON/OFF Button OFF.
- 3 Close the water supply valve and disconnect the electrical power supplied to the unit.
 

Do not touch with wet hands.
- 4 Fully open all hot water fixtures/faucets.
 
- 5 Open all drain plugs and drain the water out of the unit.
- 6 When the water is completely drained, replace all drain plugs and close the hot water fixtures/faucets.

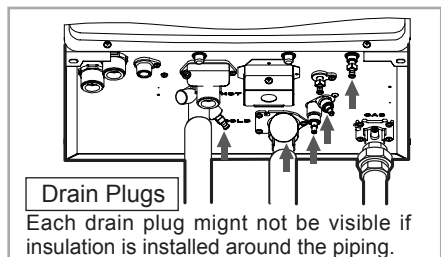

Preventing Damage from Freezing-3

Turning the Unit Back On

1. Check that all drain plugs are inserted.
2. Check that all hot water fixtures/faucets are closed.
3. Follow the procedure on p.16 "Initial operation", steps 1 through 4.
4. Make sure that the area around the appliance is well ventilated; open a window or a door if necessary. Then, operate the unit and verify that condensate is coming out of the drain pipe.
(During normal use of the water heater, condensate will begin to discharge from the drain pipe within 15 minutes of use. However, depending on the season and/or installation site conditions, it may take longer.)

* If water does not appear at the end of the drain line, a qualified service technician must clean the condensate line.

DANGER



Be sure to do.

After the water heater has been out of use for a long time make sure that you fill the condensate trap with water.

This is to prevent dangerous exhaust gases from entering the building.

Failure to fill the condensate trap could result in severe personal injury or death.

(By performing step 4 as described above, the condensate trap will automatically fill itself with water.)

Regular Maintenance-1

Periodic Inspection

CAUTION



To prevent burns or scalding, turn off the power button and wait until the equipment cools before performing maintenance.

Be sure to do.

[When supplying combustion air from the indoors]

Check For smear or blockage with dust, oil, etc. at the air supply vent.
If blocked, remove the build-up with a vacuum cleaner or damp towel.

* Do not permanently remove the Inlet Screen.

Check For laundry, newspaper, timber, oil, spray cans and other combustible materials. near the heater or the exhaust vent terminal.

Check For blockage at the drain pipe discharge.

air supply vent

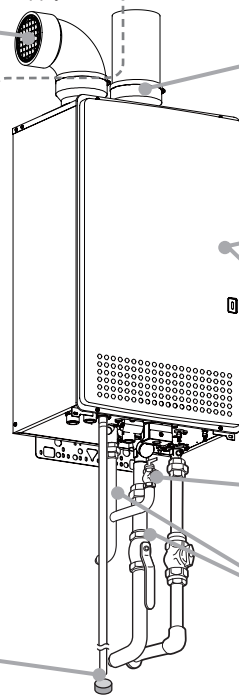

Check For dust and soot in the exhaust vent or exhaust vent terminal.

Check For abnormal sounds during operation.

Check For abnormalities in external appearance, discoloration or flaws.

Check For proper operation of pressure relief valve.

Check For water leaks from the equipment and piping.

(Ex. NCC300DV (GQ-C5032WZ-FF US))

Periodic Maintenance

Equipment

Wipe the outside surface with a wet cloth, then dry the surface. Use a neutral detergent to clean any stains. If an external condensate neutralizer is installed, periodic replacement of the neutralizing agent will be required. Refer to the instructions supplied with the neutralizer for suggested replacement intervals.

Remote Controller

Wipe the surface with a wet cloth.

- Do not use benzene, oil or fatty detergents to clean the remote controller; deformation may occur.
- The remote controller is not water resistant. Keep it dry.

Regular Maintenance-2

Periodic Maintenance

Water Drain Valve (with Water Filter)

If the water drain valve (with water filter) is covered with debris, the hot water may not run smoothly, or the unit may put out cold water. Check and clean the filter as explained below.

* **To avoid burns, wait until the equipment cools down before draining the water.**

The appliance will remain hot after it is turned off.

1. Close the water supply valve.
2. Open all hot water fixtures/faucets.
3. With a bucket ready, remove the inlet and outlet drain plugs (about 0.45 gallon (1.7 L) will drain out)
4. Take the water drain valve (with water filter) out of the inlet. (See illustration to right).
5. Clean the water drain valve (with water filter) with a brush under running water.
6. Replace the water drain valve (with water filter) and close the drain plugs.
(Take care not to lose the packing.)
7. Close all hot water fixtures/faucets.
8. Open the water supply valve and check that water does not leak from the drain plugs or water drain valve (with water filter).

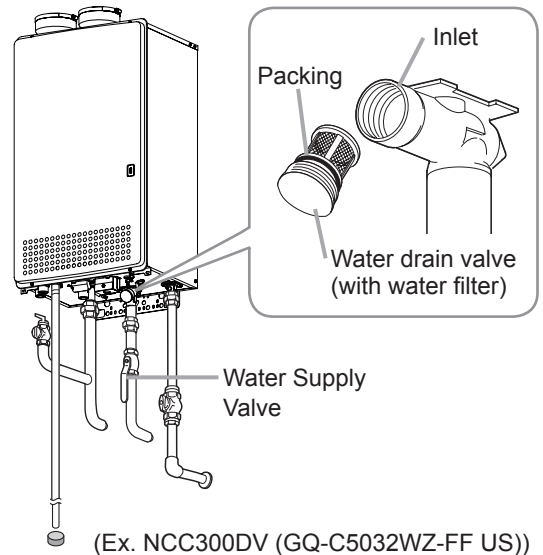

Water Quality and Maintenance

For people who live in a hard water area, periodical flushing is necessary. If the Heat Exchanger is not flushed, the Scale Build-up may cause damage to the Heat Exchanger. In this case, this water heater will detect the Scale Build-up in the Heat Exchanger and then the error code "C*#" will be displayed on the Remote Controller.

When the error code "C*#" is flashing on the Remote Controller, the Heat Exchanger needs to be flushed to prevent damage from Scale Build-up. Please contact Noritz America for more information about flushing the Heat Exchanger. (<http://support.noritz.com/> or 866-766-7489)

* * = 1, 2, 3, 4, F

= 0, 1, 2, 3, 4, 5, 6, 7, 8, 9

Damage to the water heater as a result of below is not covered by the Noritz America Limited Warranty. To ensure full warranty coverage, treat or condition water that exceeds the target levels provided in this table.

- Hard water
- Poor water quality (See the below list.)
- The water heater has displayed a "C*#" error code indicating Scale Build-up, but the heat exchanger has not been flushed.

Total Hardness**	: 200 mg/L (12 gpg) or less
Aluminum	: 0.05 to 0.2 mg/L or less
Chloride	: 250 mg/L or less
Copper	: 1 mg/L or less
Iron	: 0.3 mg/L or less
Manganese	: 0.05 mg/L or less
pH	: 6.5 - 8.5
Total Dissolved Solids	: 500 mg/L or less
Zinc	: 5 mg/L or less
Sulfate ion	: 250 mg/L or less
Residual chlorine	: 4 mg/L or less

** Maximum limit suggested by Noritz.

Source: EPA National Secondary Drinking Water Regulations (40 CFR Part 143.3)

Isolation Valves

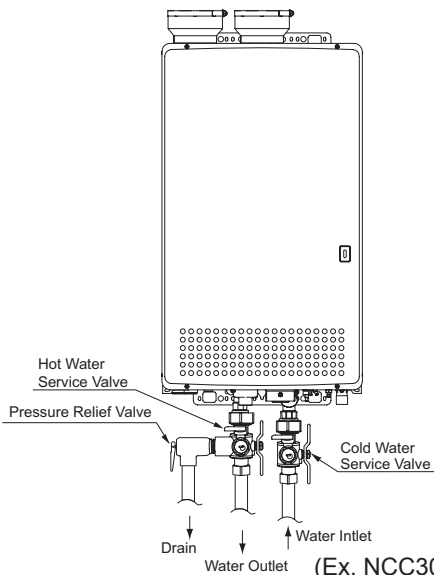

- * Isolation valves may be purchased as an accessory from an authorized Noritz wholesaler. They allow for full diagnostic testing and easy flushing of the system.
- * The kit includes two full port isolation valves and a pressure relief valve for the hot side. Contact Noritz for more information.

Troubleshooting-1

Initial Operation

Unit does not attempt to ignite when water is running.

- Check for reversed plumbing or crossed pipes.
- Check the water drain valve filter. (☞ p.36)

Unit attempts to ignite but fails

- Reset unit and try again. There may be air in the gas line.
- Have a professional check the gas supply pressure.

Temperature

Hot water is not available when a fixture is opened.

- Are the gas and water supply valves fully open?
- Is the water supply cut off?
- Is the hot water fixture/faucet sufficiently open?
- Is the gas being cut off by the gas meter?
(Can other gas devices such as stoves be used?)
- (For LP) Is there enough gas in the tank?
(Can other gas devices such as stoves be used?)
- Is the water drain valve filter clogged? (☞ p.36)
- Is the power button turned on?

No water is available when a fixture is opened.

- Is the water supply cut off?
- Is the heater frozen?

The hot water is not the correct temperature.

- Is the hot water fixture/faucet sufficiently open?

Water takes time to become hot when turning the hot water fixture/faucet.

- Have you allowed enough time for the cold water in the pipes to drain out?

The water is too hot.

- Are the gas and water supply valves fully open?
- Is the water temperature setting appropriate? (☞ p.19)
- If the water supply temperature is high, it is possible for the temperature to be higher than the temperature set on the remote controller.
- If only a small amount of hot water is demanded, it is possible for the temperature to be higher than the temperature set on the remote controller.

The water is not hot enough.

- Are the gas and water supply valves fully open?
- Is the water temperature setting appropriate? (☞ p.19)
- If the amount of hot water required is very high, it is possible for the temperature to be lower than the temperature set on the remote controller.
Decrease the amount of hot water passing through the unit and the temperature should stabilize.

(Continued)

<p>The water is cold when only a single fixture is open.</p>	<ul style="list-style-type: none">• The unit will not heat the water if the flow rate is less than 0.5 gallons (2L) per minute. Open the fixture more or open other fixtures so that a greater flow passes through the unit, and the unit should begin heating again.
<p>Fluctuations in hot water temperatures.</p>	<ul style="list-style-type: none">• Set water temperature at 115°F to 120°F or 48°C (118°F) to 50°C (122°F). This will allow you to use a higher flow of hot water thus meeting the minimum flow requirement of 0.5 GPM (2L/min.).• Clean the water filter of any debris (👉 p.36)
<p>Setting temperature cannot rise.</p>	<ul style="list-style-type: none">• Is the maximum temperature setting appropriate? (👉 p.23)

Amount of Hot Water

<p>The amount of hot water at a certain fixture is not constant.</p>	<ul style="list-style-type: none">• When hot water is demanded at other fixtures, the amount available may be reduced. The maximum flow available from this unit is 12.5 GPM (47.4L/min.) at a 45°F (25°C) temperature rise.• Pressure fluctuations and other plumbing conditions can cause the temperature and pressure at a fixture to be unstable, but it should stabilize after a short time.• There are some types of hot water taps that discharges large volumes of hot water at first but stabilize after time.• To keep the temperature stable, the heater limits the amount of water that can flow through it to a small amount initially, but the amount increases over time.
<p>The amount of hot water in the tub is less/more than the set amount.</p>	<ul style="list-style-type: none">• When hot water is used for other fixtures while filling the bath tub, the tub will not fill as much.• If there is water in the tub already, or when filling is stopped and restarted, the tub will fill more.
<p>The flow meter alarm does not sound even when filled to the set amount.</p>	<ul style="list-style-type: none">• The flow meter alarm is set to sound when hot water is continuously discharged for the set volume of water. If mixing valves are used, or if cold water is mixed with hot water at the fixture, the tub will fill more than the setting of the flow meter alarm.
<p>Amount of hot water available has decreased over time.</p>	<ul style="list-style-type: none">• Is the water filter clogged? (👉 p.36)• If the supply water is hard and has not been treated, scale can build-up in the water heater and decrease the maximum amount of hot water available. Scale can be removed from the water heater by flushing the unit periodically. To prevent scale from forming in the water heater, a water softener or scale inhibitor is recommended.

Troubleshooting-2

Remote Controller

<p>The power ON/OFF indicator does not light up.</p>	<ul style="list-style-type: none"> • Has there been a power failure? • Is the power connected properly?
<p>The water temperature changes after a power failure or when the power is disconnected.</p>	<ul style="list-style-type: none"> • The temperature setting and the flow meter alarm setting may both need to be reset after a power outage.
<p>The clock display shows "- : - -".</p>	<ul style="list-style-type: none"> • If the time is not displayed on the clock, either a power failure has occurred or power was disconnected resulting in the display showing "- : - -". (☞ p.17)
<p>The flow meter alarm does not sound or it sounds before the bathtub has been filled to the set amount.</p>	<ul style="list-style-type: none"> • The flow meter alarm is set to sound when hot water is continuously discharged for the set volume of water. If hot water is used for other fixtures while filling the bath tub, the alarm will sound before the tub is full. • If mixing valves are used, or if cold water is mixed with hot water at the fixture, the tub will fill more than the setting of the flow meter alarm.
<p>The setting cannot be changed when a button is pressed.</p>	<ul style="list-style-type: none"> • The remote controller is locked. While the remote controller is locked these buttons  cannot be used. (☞ p.22)
<p>[For recirculation systems] Flame symbol lights up or goes out.</p>	<ul style="list-style-type: none"> • During recirculation operation, the water heater will turn on and off to keep the hot water pipes up to temperature.

Sounds

<p>The fan can be heard after operation is stopped. A motor can be heard when turning the unit ON or OFF, when opening or closing a fixture, or after the unit has been running for a while.</p>	<ul style="list-style-type: none"> • These noises indicate the proper operation of devices which are designed to let the unit reignite more quickly, and ensure the water temperature is stable.
<p>The fan can be heard when it is very cold outside.</p>	<ul style="list-style-type: none"> • The fan may run to prevent freezing.

Other

<p>The Heater stops burning during operation.</p>	<ul style="list-style-type: none"> • Are the gas and water supply valves fully open? • Is the water supply cut off? • Is the hot water fixture/faucet sufficiently open? • Is the gas being cut off by the gas meter? (Can other gas devices such as stoves be used?) • (For LP) Is there enough gas in the tank? (Can other gas devices such as stoves be used?)
<p>White smoke comes out of the exhaust vent on a cold day.</p>	<ul style="list-style-type: none"> • This is normal. The white smoke is actually steam.
<p>The hot water is turbid.</p>	<ul style="list-style-type: none"> • This is harmless. Small bubbles appear as the air in the water is heated and depressurized rapidly to atmospheric pressure.
<p>The water appears blue The bath tub/wash-basin has turned blue</p>	<ul style="list-style-type: none"> • Coloration to a blue color may be noticed from small traces of copper ion contained in the water and fat (furring). However, there are not problems concerning health. Coloration of the bath tub/wash-basin can be prevented by cleaning frequently.
<p>Frequent water discharge from the drain pipe.</p>	<ul style="list-style-type: none"> • Condensation forms inside the unit during operation and is discharged from the drain pipe.
<p>A small amount of water is discharged from the pressure relief valve.</p>	<ul style="list-style-type: none"> • This is normal. When the water heater is under high pressure, a small amount of water may be discharged from the pressure relief valve.

Troubleshooting-3

Checking for Error Conditions

When a failure occurs, information relating to the error blinks on the display. The error alarm may also continuously sound.

● Error Code Display Screen ●

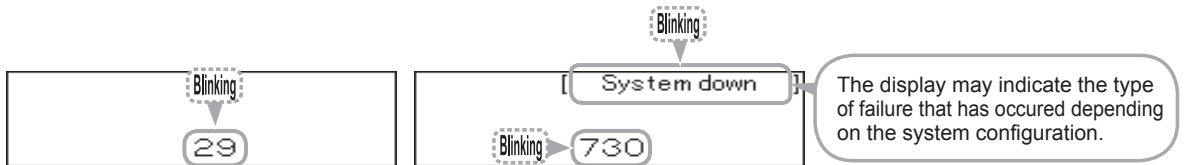

Error Code	Cause	Action
11	Ignition error	Check whether the gas valve is open. Press the power button to turn the unit off, open a hot water fixture/faucet, and turn the unit back on. If the flashing number doesn't return the problem is solved.
29	Clogging of condensate trap or drain pipe	Check to see if the condensate drain pipe is clogged or frozen (p.8) Contact the installer or Noritz America Technical Support for assistance.
90	[When supplying combustion air from the indoors] The air supply vent may be clogged.	Clean the air supply vent.(p.35) If the display continues, contact the nearest Noritz agent.
	Abnormal combustion, low gas supply pressure	Have a professional check the gas supply pressure. Contact the nearest Noritz agent.
99	Abnormal combustion	Contact the nearest Noritz agent.
C * # *=1-4, F #=0-9	The unit detects Scale Build-up in the Heat Exchanger. (Warning indication, and then the unit will shut off before long.)	The unit may shut off and lock before long. Needs to be flushed the Heat Exchanger to remove the Scale Build-up. If the unit will shut off and locked for this error, the unit can temporarily operate by disconnecting electrical power until the Heat Exchanger can be flushed. Contact Noritz America for more information about flushing the Heat Exchanger. (866-766-7489)
C F # #=0-9	The unit detects the Scale Build-up in the Heat Exchanger many times (The unit is locked.)	The unit is locked because of repeated Scale Build-up error codes. Must flush the Heat Exchanger to remove the Scale Build-up. Before flushing the Heat Exchanger, contact Noritz America for more information.(866-766-7489)

Contact Noritz America if:

- Any other error code appears.
- An error code is indicated again after the above actions were followed.
- There are any other questions.

● To Stop the Error Alarm ●

Press the  button (the indicator will turn off).

Follow-up Service-1

Requesting Service

First follow the instructions in the troubleshooting section (p.38 to p.42).
 If the error is not corrected, contact Noritz America Technical Support at 866-766-7489.

We will need to know:

- The Model**(check the rating plate)
 *See p.4 for the location of the label
- Date of purchase**(see the warranty)
- Details of problem** (flashing error codes,
 etc., in much detail as possible)
- Your name, address, and telephone number**
- Desired date of visit**







* A request for service may be rejected if the water heater is installed in a location where working on the unit may be dangerous. Contact a plumber.

● If an error code is displayed, the model name and code can be checked ●





< Ex:Error code >

* If more than one water heater is installed, this procedure cannot be used.



Operation	Screen Display	Description
1 Press the  button.	 Model code Product name of water heater is displayed	
2  button is pushed again. (Return to previous screen.)	 <Screen display (Example)>	* If the display is left untouched for approximately 60 seconds, it will return to the previous screen.

Follow-up Service-2

● Press the  button to check the status of the system ●

Operation	Screen Display	Description
1 Press the  button inside the cover.	<pre>System [Rrcr] Active [04] Units [06] Pump1 [OFF] Online [04] Pump2 [ON]</pre> <p><Screen display (Example)></p>	<p>* Status can be checked regardless of whether the  button is ON/OFF.</p> <p>* If the  button is pushed or it is left untouched for approximately 10 minutes, it will return to the previous screen.</p>

● Identifying units that require service (system dependent).

Press the  button twice inside the cover.	<pre>Error unit 1 - - - - 6 - - - - - - - - - - - - - - - - - -</pre> <p><Screen display (Example)></p>	<p>* If you press the  button, the screen of step 1 is displayed.</p> <p>If you press the  button, the screen returns to the previous screen.</p>
--	---	---

Warranty

A warranty registration card is included separately.

Be sure that the plumber, date of purchase and other necessary items are filled in.

Read the content carefully, and keep the warranty card in a safe place.

For repairs after the warranty period, there will be a charge on any service, and service will only be performed if the unit is deemed repairable.

Period of Time for Stocking Repair Parts

Noritz will stock repair and maintenance parts for this unit for the time period from the date of the original installation as follows: twelve (12) years for the heat exchanger and ten (10) years for remaining parts.

Reinstallation

If you want to reinstall the appliance at a different location, confirm that the gas and power supply indicated on the rating plate are available at the new location. If you are not sure, consult the local utility company.

Gas Conversion

If you move to a region that uses a different type of gas or if the local gas supply is converted, replacement of the gas manifold and adjustment of the appliance will be necessary. This work must be performed by either Noritz or a qualified service agency and will be charged for even during the warranty period. The qualified installer will also be responsible for purchasing the gas conversion kit directly from the manufacturer.

For more information, contact Noritz America Technical Support at 866-766-7489.

WARNING

The gas conversion kit shall be installed by a qualified service agency* in accordance with the manufacturer's instructions and all applicable codes and requirements of the authority having jurisdiction. The information in the instructions must be followed to minimize the risk of fire or explosion or to prevent property damage, personal injury, or death. The qualified service agency is responsible for the proper installation of this kit. The installation is not proper and complete until the operation of the converted appliance is checked as specified in the manufacturer's instructions supplied with the kit.

* A qualified service agency is any individual, firm, corporation, or company which either in person or through a representative is engaged in and is responsible for the connection, utilization, repair or servicing of gas utilization equipment or accessories; who is experienced in such work, familiar with all precautions required, and has complied with all of the requirements of the authority having jurisdiction.

Before the gas conversion is performed, verify the proper gas conversion kit with your water heater model on the table provided below.

Conversion Kit	Model	Conversion Type
CK-79	NCC300OD (GQ-C5032WZ US) NCC300DV (GQ-C5032WZ-FF US)	Natural Gas to Propane
CK-80	NCC300OD (GQ-C5032WZ US)	Propane to Natural Gas
CK-81	NCC300DV (GQ-C5032WZ-FF US)	

The following parts are supplied in the conversion kit. These items will replace the existing parts that are currently installed in the unit. Make sure that all parts are replaced and properly installed by a qualified service agency.

* A Noritz remote controller and a digital gas manometer are required to complete the installation. Do not proceed if this equipment is not immediately available.

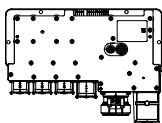

Manifold Plate



O-Ring

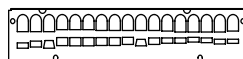

Damper



Conversion Kit Label

After the necessary parts have been replaced on the unit, the remote controller is then used to adjust the settings on the water heater for use with the proper gas type.

The gas pressure values at both the gas supply inlet fitting and at the manifold inlet on the unit are verified by the installer. Proper adjustments will be made to ensure safe and efficient operation.

Once this is completed, a final gas leak check will be performed to confirm that all parts have been securely installed.

If you notice the smell of gas at any time after the installation has been completed, turn the water heater off and contact your gas supplier immediately.

Specifications

- Specifications may be changed without prior notice.
- The capacity may differ slightly, depending on the water pressure, water supply, piping conditions, and water temperature.

Specifications

Item		Specification	
Model Name		NCC300DV (GQ-C5032WZ-FF US)	NCC300OD (GQ-C5032WZ US)
Type	Installation	Indoor Wall Mounted	Outdoor Wall Mounted
	Air Supply/Exhaust	Power Vented	
Ignition		Direct Ignition	
Operating Pressure		15-150 psi (Recommended 30 psi or more for maximum performance)	
Minimum Activation Flow Rate*		0.5 GPM (2.0 L/min)	
Minimum Operating Flow Rate*		0.29GPM (1.1 L/min)	
Dimensions (Height) x (Width) x (Depth)		32.7" (830mm) x 18.9" (480mm) x 14.2" (360mm)	
Weight		130 lbs.	
Water Holding Capacity		0.8 Gallon (3.1 L)	
Connection Sizes	Water Inlet	NPT 1"	
	Hot Water Outlet	NPT 1"	
	Gas Inlet	NPT 3/4"	
	Condensate Drain	1/2" Threaded	
Power Supply	Supply	120 VAC (60Hz)	
	Consumption	NG : 121W LP : 116W Freeze Prevention 345W	NG : 107W LP : 102W Freeze Prevention 289W
Materials	Casing	Zincified Steel Plate/Polyester Coating	
	Flue Collar	Stainless Steel	
	Primary Heat Exchanger	Copper Sheeting, Copper Tubing	
	Secondary Heat Exchanger	Stainless Steel Sheeting, Stainless Steel Tubing	
Safety Devices		Flame Rod, Thermal Fuse, Lightning Protection Device (ZNR), Overheat Prevention Device, Freezing Prevention Device, Fan Rotation Detector	
Accessories		Remote Controller, Remote Controller Cord, Anchoring Screws, Drain hose (With clamp)	Remote Controller, Remote Controller Cord, Anchoring Screws

* Specifications may be changed without prior notice.

* The capacity may differ slightly, depending on the water pressure, water supply, piping conditions, and water temperature.

* Minimum operating flow rate may change by setting temperature and water temperature.

Performance

Item		Maximum Performance	Minimum Performance
Gas Consumption	NG	300,000 btuh	15,000 btuh
	LP	300,000 btuh	15,000 btuh
Maximum Hot Water Capacity	45°F (25°C) Rise	12.5 GPM (47.4 L/min.)	
Capacity Range		0.5-13.2 GPM (2-50 L/min.)	
Temperature Settings	°F Mode:	100-150°F (In 5°F intervals), 160, 170, 185°F (14 Options)	
	°C Mode:	37-48°C (In 1°C intervals), 50-85°C (In 5°C intervals) (20 Options)	

Default Settings

Items	Default setting
Clock display (unset)	—:—
Hot water temperature	110°F / 40°C
Hot water volume	alarm off

Customizable Settings (☛ P23 - 25)	Default setting	
Maximum Output Temperature	185°F / 85°C	★
"Powersave dsply" and clock display	No-1	★
Brightness of the display screen when the remote controller is turned on.	Normal	★
Operation sound of remote controller	Yes	★
Notification when a failure is generated	Yes	★

★ Indicates an item that can be restored to default.
 See p.25 "Restoring Default Settings".